

imagine

Additional security - *PAS 24 ready.*



imagine

Contents

Pg.3	Introduction	Pg.9	Colours (Variations)
Pg.4	Market Info	Pg.10	Imagine Patio Hardware
Pg.5	Features Et benefits	Pg.11	ERA Security guarantee
Pg.6-7	Facts Et figures	Pg.12-13	Imagine Patio profile / hardware / ancillary chart
Pg.8	Thermal performance	Pg.14-15	Imagine Patio profile / hardware / ancillary chart



Introduction

Our Imagine Patio Door was first launched in 2015 and has been a welcome addition to the Imagine range. However, in order to offer installers additional selling benefits and homeowners a more appealing security enhancement, VEKA Group is pleased to introduce an innovative yet simple PAS 24 ready solution to the Imagine Patio Door.

Partnering with ERA, with their long-standing heritage of high quality security hardware and innovation, we have developed a high security interlock claw profile design which provides a host of benefits for the entire supply chain, from fabricator to homeowner.



In order to make the PAS 24 ready Imagine Patio Door options as simple as possible, VEKA will be stocking locks and hardware, as detailed on page 10.

With its clean aesthetics, high quality and raft of selling benefits, the Patio Door fits comfortably with the rest of Imagine range. Available in our full Variations range of colours and the option of chamfered or sculptured beads.

Enhanced security testing has been carried out to PAS 24:2016, completed using the largest possible sash size of 1500mm wide 2300mm high. This allows VEKA to cascade test data to fabricators and installers of the Imagine Patio Door in a structured way that enables compliance with Document Q of The Building Regulations.

At a stroke the new PAS 24 ready Imagine Patio Door has greatly simplified achieving this security standard, sweeping aside many of the fabrication, installation and aesthetic challenges thrown up by more traditional solutions.



**HIGH
SECURITY**

interlock claw
profile design

imagine

Market info.



The market for traditional sliding patio doors is forecast to maintain modest growth and remains heavily dominated by PVC-U at 84% share of market.

Strengthening your offer to this market with the ability to offer a simple, cost effective and easily fabricated upgrade to meet PAS 24 requirements, aligns perfectly with the fact that sliding patio doors are historically considered a vulnerable part of the home, and research shows us that improved security is still a prime motivator for homeowners to invest in new doors and windows.

Chart

Trends in the Patio Door Market in Housing in Great Britain 2000 to 2016 by Door Type (000 Doorsets)

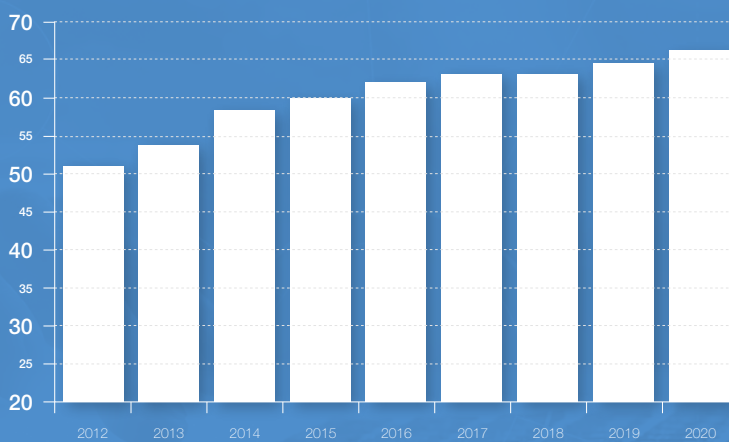

PVC-U Patio Door Units 000's

Source: D&G Consulting 2017

SIMPLE
COST EFFECTIVE
UPGRADE

Features & benefits



Benefits to Fabricators



- Cost effective when compared to fabrication that requires preparation for plunge bolts and additional locks
- Other than the fitting of the lock extensions and keep plates everything else remains the same as the existing patio fabrication
- Reduced service calls due to misalignment of plunge bolts / locks
- Quick & easy in fabrication
- No routing required for plunge bolts or additional locking mechanisms
- No routing through profile and steel reinforcement sections to accommodate plunge bolts and additional locking devices
- No routing through aluminium interlocks to accommodate plunge bolts and additional locking devices
- No routing or recessing of sections to accommodate plunge bolt and hook lock keep plates
- Standard handle height and mode of operation satisfies DDA & LTH (Disability Discrimination Act & Lifetime Homes)
- Access to bigger market where SBD security is required such as new build and commercial (SBD testing required)

Benefits to Installers



- Standard patio installation technique
- No issues or time spent with alignment of plunge bolts
- No issues with alignment of hook locks and keep plates used by some competitors
- No issues with locking if doors move due to thermal expansion, with no plunge bolts to align
- Other than the additional top and bottom locking points the door remains the same
- Use of aluminium interlock for increased security
- Reduced service calls due to misalignment of plunge bolts / locks
- Opens more opportunities to offer products where greater security is required
- The ability to offer an enhanced security upgrade to homeowners that is cost effective, simple to install and easy to operate

Benefits to Homeowners



- Easy to operate with an extended lever on handle to reduce operating forces
- Aesthetically pleasing sight lines - no unsightly locks on face of profiles
- No fiddly plunge bolts to operate to achieve secure closure
- Easy access in case of emergency - no additional plunge bolts or locks to operate hindering escape
- No high and low plunge bolts to operate if the homeowner has limited body movement
- No problems with alignment of hooks and keeps which could prevent doors being locked in secure position.
- By closing the door and locking the mechanism the door is fully secured without the need for additional locking devices
- Peace of mind that the door is covered by ERA's 5 Star Security guarantee against break in.

And peace of mind that the most vulnerable door in any property is now protected against forced entry

Designed to achieve PAS 24 and Doc Q

High security interlock claw design

12 point locking with option of additional locking keeps via extensions

Profile specific keeps

TS007 compliant (3 star cylinder & handle combination)

Developed in partnership with ERA

Homeowner protection by the industry leading ERA 5 Star Security Guarantee

imagine

Imagine Patio Doors boast impressive figures in terms of thermal performance, security, versatility and environmental credentials.

Here are its vital statistics...

**U Value of
1.2**

PAS 24 ready

Results achieved with the maximum size

1500mm x 2300mm opening sash

*PAS 24 locking kit currently

2 pane only

**WER Rating
of A⁺³**

* Full steel reinforcement,
tripled glazed.



imagine

29
colour options
14 FROM STOCK

Triple glazed
ready upto
32mm

Meets the
requirements of
document

Q

Choice of
2, 3 or 4* pane
configurations

*PAS 24 locking kit currently
2 pane only

Thermal performance



Calculations for Imagine Patio U-Values and Energy Ratings are in the table below.

The Imagine Patio can achieve an **A(+3)** rating at its top specification.

The VEKA Group energy rating calculator Ask a member of our Technical Team about VEKA Group's window and door energy performance calculator – a BSI notified and BFRC certified tool.

The calculator is unique to each fabricator and their products, and allows for the generation of accurate SELs/DSELs in accordance with the BFRC and notified U-Values for CE Marking in accordance with EN 14351.



Product Spec.	Reinforcement	Imagine Patio	
Double Slider Double Glazed Best Rating	Full Steel	A(2)	1.5
Double Slider Double Glazed Best U-value	Full Steel	C(-14)	1.4
Double Slider Triple Glazed Best Rating	Full Steel	A(3)	1.2
Double Slider Triple Glazed Best U-value	Full Steel	C(-18)	1.2



Colours



Colour	Sides/Base		Ref	RAL Colour	Imagine Patio
Rosewood	2	Brown	Rswd	8015	Ex-Stock
Rosewood	1	White	Rswd	8015	Ex-Stock
Golden Oak/Chry	2	Caramel	GOak	8001	Ex-Stock
Golden Oak/Chry	1	White	GOak	8001	Ex-Stock
Irish Oak	1	White	IOak	1011	Ex-Stock
Cream	1	White	Crem	9001	Ex-Stock
Cream	2	White	Crem	9001	Ex-Stock
Beck Brown	1	White	Blick	8022	Ex-Stock
White	2	White	White	9010	Ex-Stock
Anthracite Grey	1	White	Anth	7016	Ex-Stock
Anthracite Grey	2	White	Anth	7016	Ex-Stock
Anthracite Grey Smooth	1	White	Anth#	7016	Ex-Stock
Silver Grey	2	White	Silv	7001	4 weeks
Slate Grey	1	White	Site	7015	4 weeks
Irish Oak	2	Caramel	IOak	1011	Ex-Stock
Chartwell Green	1	White	CGrn	-	Ex-Stock

Ex-Stock

4 weeks

Lead times refer to deliveries to the Fabricator

MOQ

1 Pack (made to order by agreement)

Colours

The following colours are available as Ex-stock.

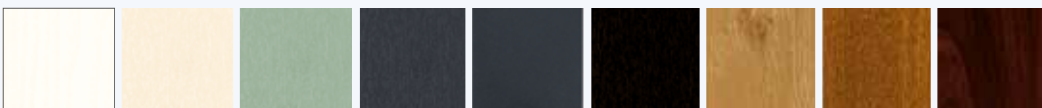

White Cream Chartwell Green Anthracite Grey Anthracite Grey Smooth Beck Brown Irish Oak Golden Oak Rosewood

The following colours are available to agreed lead times, typically 4 weeks.

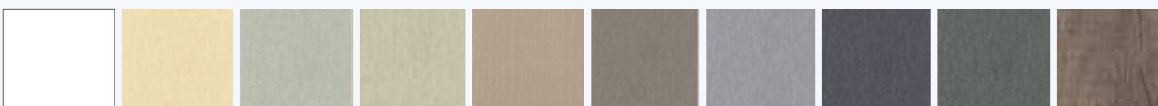

Brilliant White Light Ivory Agate Grey Pebble Grey Windsor Balmoral Silver Grey Slate Grey Basalt Grey Monument Oak



AnTEAK Natural Oak Mountain Pine Light Oak Walnut V Regency A Siena PN Dark Green Steel Blue Dark Red

imagine

Hardware



A fantastic colour choice of Imagine Patio handles, all available directly from VEKA.



PAS 24 ready locking kit comes with the following hardware. Suitable for 2 pane (single sliding door) as standard.

Lock	Interlock	Handle / Cylinder	Also available
<p>Imagine Patio Door PAS 24 Locking Kit includes main lock + keep, top & bottom extensions + keeps / anti lift, connecting plates and fixed pane location mouldings (MOQ box of 5)</p>	<p>Interlocks (2x2.4m) available in painted Black and painted White (MOQ 10 lengths)</p>	<p>Patio Door 3 star cylinder and handles (TS007 compliant) — Pembroke Euro Cylinder Handle Extended Lever Invincible locking — available in White, Chrome, Gold or Graphite (MOQ box of 5) — Fortress 3 Star Euro Cylinder dual colour (MOQ box of 10)</p>	<p>VEKA frame keep trim 995mm (packed in 10's) — VEKA keep packers (Packed in 50's)</p>

NOTE: Guarantee on all hardware is 10 years mechanical. Surface finish for F&F Hardex tends to be by customer but typically ERA offer 1 to 5 years depending upon commercials. There is currently no stainless option but this could be reviewed given sufficient demand

NOTE: The ERA Total Security Guarantee would only apply when using an ERA 3 star cylinder (Invincible or Fortress)

NOTE: Once tested with a kitemarked cylinder any other TS007 3 star cylinder could be substituted for kitemark purposes but would not be covered under ERA Total Security guarantee.

NOTE: For PAS 24 compliance products must be manufactured in accordance with VEKA technical manual using all parts as tested.

Five Star Guarantee

Homeowners that choose the Imagine Patio Door can also benefit from ERA's Five Star Guarantee. By incorporating high security ERA components into the Imagine Patio, we've ensured that you can offer your customers the UK's most comprehensive home security guarantee.



Five major benefits to homeowners:



Savings on the cost of their home insurance

Most insurers recognise that having high security hardware on doors and windows reduces the risk of forced entry and should result in reduced premiums.



24/7 help

The ERA Five Star Guarantee gives homeowners access to a FREE call out service operating 24 hours a day, 365 days a year.



Up to £1,000 excess paid

The quality and reliability of our components and the security provided by them is such that we guarantee them against forced entry for 10 years. We will even pay the excess on any home insurance claim due to the failure of one of our products - so you can rest assured that you're covered.



Up to £1,000 towards a repair or replacement

Again, ERA is so confident in the Imagine Patio Door's capacity to deter burglars that, if the door fails, they will pay up to £1000 toward the cost of repair or replacement.



A £1,000 cheque

In the unlikely event of a break-in succeeding through the failure of an Imagine ERA Five Star Guaranteed door, the homeowner will be given a £1000 cheque to compensate them for the inconvenience.



www.erafivestar.com

imagine

140123 SBD Patio Door Locking Kit

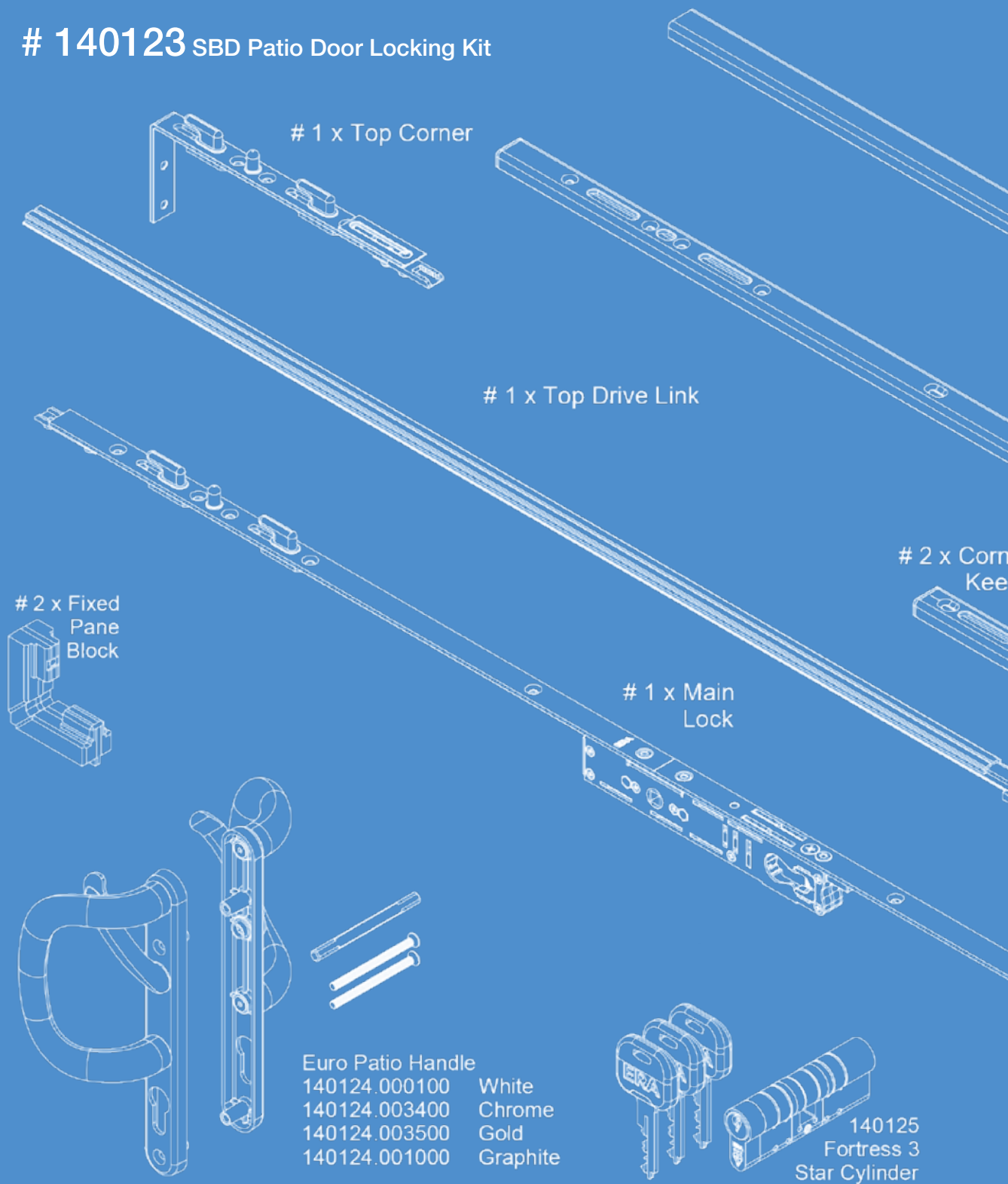

Euro Patio Handle
140124.000100 White
140124.003400 Chrome
140124.003500 Gold
140124.001000 Graphite

140125
Fortress 3
Star Cylinder

DO NOT SCALE the drawings shown are visual representations only. VEKA PLC has the right to alter the designs, specification & descriptions without prior notice as part of our policy of continuous development and improvements.

Anti Lift Block

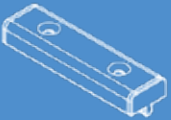

140126
Frame Trim
(optional Extra)

140127
Keep Packer
(optional Extra)



1 x Main
Keep

2 x Drive
Link Fixing
Screws



1 x Bottom
Drive Link

1 x Bottom
Corner

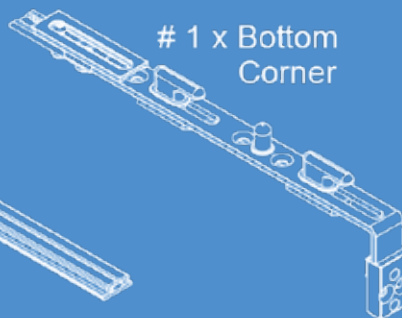
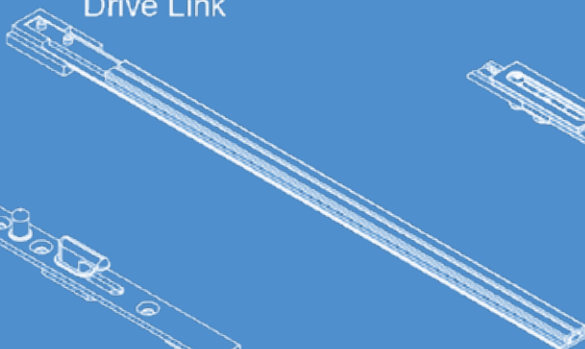

imagine

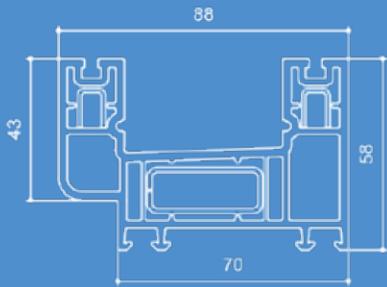

58mm Outer Frame 105178
 Steel U Channel 113018
 Steel Box 713104 (S51104)

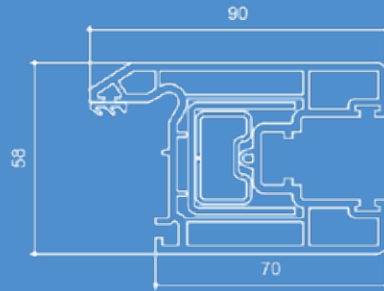

Patio Sash 705151 (P58151)
 Steel Channel 713029 (S00029)
 *Steel Channel (Prep'd) 713804 (S00127)
 Steel Box (400mm) 713119 (S00119)
 Steel Box (4000mm) 713124 (S00124)

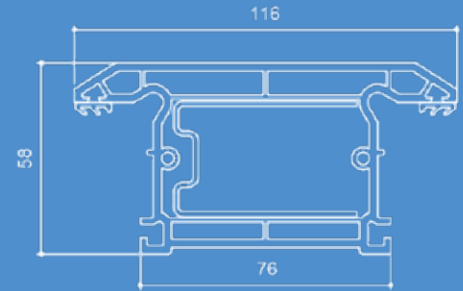

Patio Midrail 702152 (P58152)
 Steel Channel 713166 (S00166)

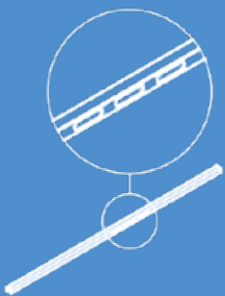

***Steel Channel (Prep'd) 713804.900001**



Outer Frame Cover 705152 (P10152)



Sash Cover 709112 (P10112)



Draught Strip 109064

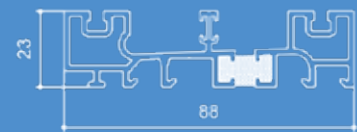

Patio Low Threshold (Silver or Gold) 104324



Gasket 712044 (G00044)



6.7-750-WE Woolpile 744961 (H00961)



Bead Groove Infill (Black/White) 112380



Anti Lift Device (White) 709818 (M00119)



Base Packer (Black) 709081 (M00081)



Insert (Black) 709047 (P01047)



11-800-P Woolpile 744226 (H00226)



20-800-P 55mm Woolpile 744778 (H01778)

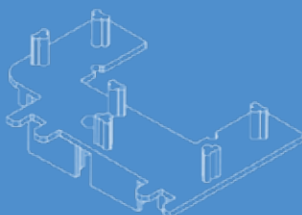

Mechanical Joint Moulding (White or Black) 109058



Mechanical Joint Reinforcement 115112



Mechanical Joint Bracket 141405



Mechanical Joint Internal Bracket 141406

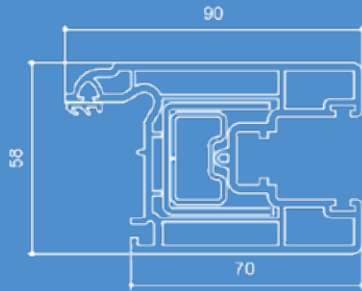

Patio Sash **703251 (P58251)**
 Steel Channel 713029 (S00029)
 *Steel Channel (Prep'd) 713804 (S00127)
 Steel Box(400mm) 713119 (S00119)
 Steel Box (4000mm) 713124 (S00124)

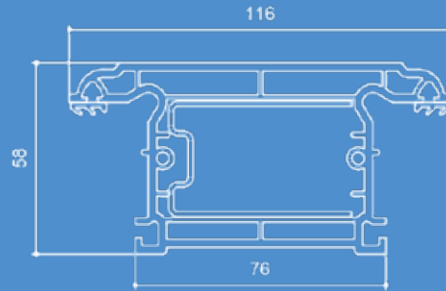

Patio Midrail **705252 (P58252)**
 Steel Channel 713166 (S00166)



28mm Bead
707427 (P10427)



28mm Bead
707432 (P10432)



32mm Bead
707426 (P10426)



Patio Track Steel
713070 (S00070)



Threshold Cover (Silver or Gold)
704361 (A00361)



Threshold
 (White or Black)
704180 (A00180)



Interlock
 (White or Black)
105377

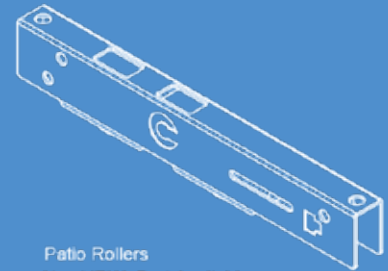

Patio Rollers
 Non VEKA Part Available
 from CILlock Engineering
 T: 01455 891604



Jamb Packer (White)
709082 (M00082)

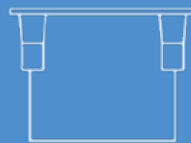

Letter Plate Cover Moulding (Black)
709194 (M00194)
 (For use with a Yale 10" Wellseal Letter Plate)

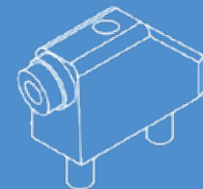

Patio Door Stop
709128 (M00128)
 (White/Brown/Caramel/Black)



Mechanical Joint Pin
744786 (H01786)
 M6 x 60 Cap Screw
744673 (H00673)

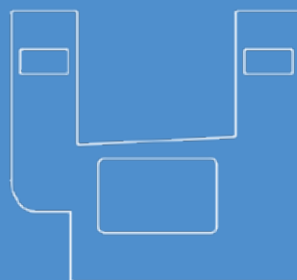

Mechanical Joint Gasket
 (White or Black)
106411

DO NOT SCALE the drawings shown are visual representations only. VEKA PLC has the right to alter the designs, specification & descriptions without prior notice as part of our policy of continuous development and improvements.

VEKA plc

Farrington Road
Rossendale Road Ind. Est.
Burnley, Lancashire
BB11 5DA

Tel: 01282 716611
Fax: 01282 725257
salesenquiry@veka.com
www.vekauk.com

imagine

Images are for illustration purpose only. We reserve the right to change product specification at any time.
Due to the limitations of the printing process we recommend that an accurate colour swatch is requested prior to ordering.
The company cannot accept any responsibility for colours or images shown in this brochure.
All information within this brochure is correct at time of going to print.



FOR NOW
FOR THE FUTURE
FOR LIFE